

Operating Manual for Pneumatic Powered Aluminum Pull-up Screen

Thank You For Choosing Our Projector Screen. Please Read This Manual Carefully Before Using Your Screen. Thanks!

Figure 1

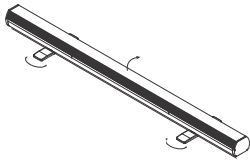

Figure 2

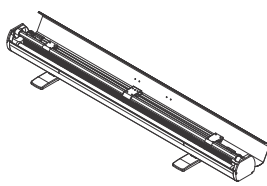

Figure 3

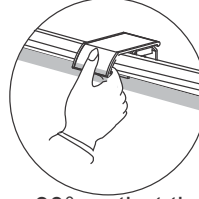
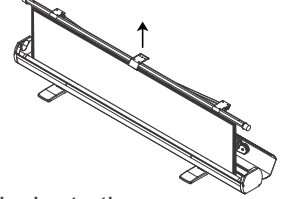

Figure 4



- Rotate the plastic stabilizing feet into place by rotating them 90° so that they are perpendicular to the screen housing. See Figure 1.
- Unlock and open the case to reveal the screen (Figure 2)
- Using the handle located in the middle of the top rod of the screen pull the screen up to the desired height. A slow steady motion is ideal. The Pneumatic powered frame will do most of the lifting for you! (Figure 3, 4)

Figure 5

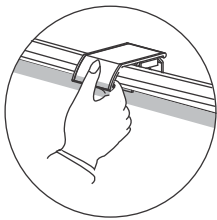

Figure 6

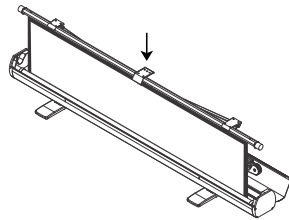

Figure 7

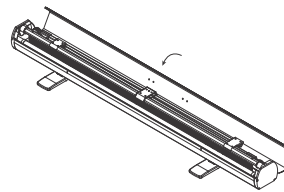
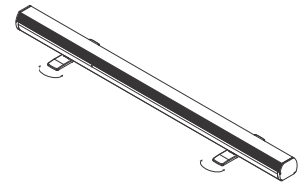
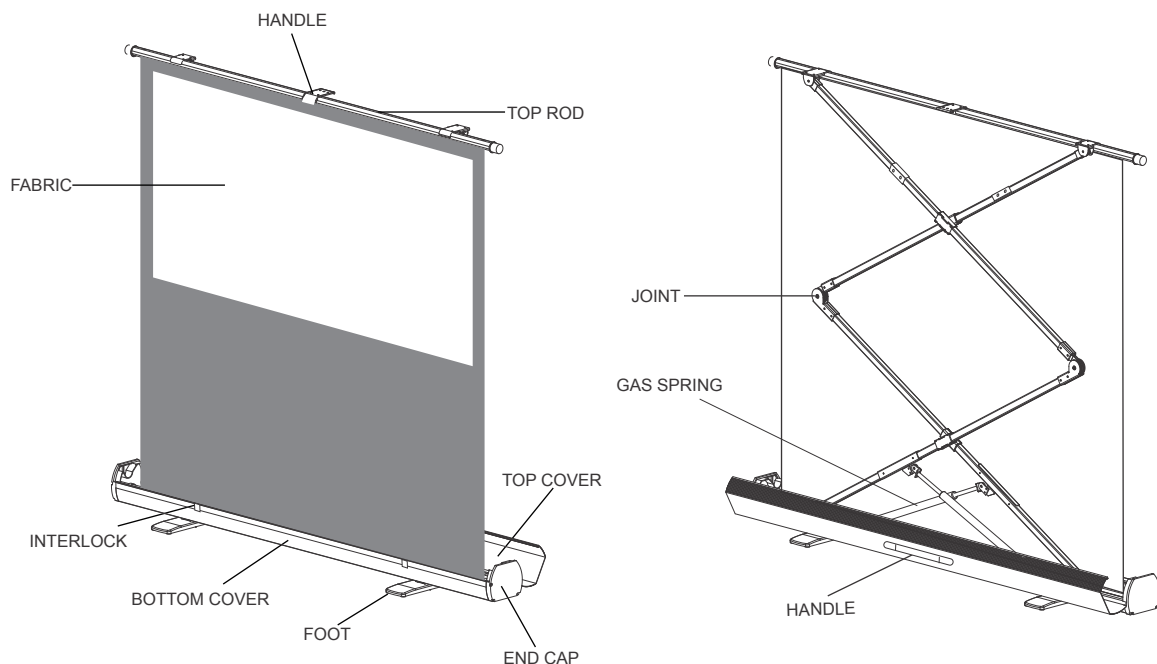

Figure 8



- To close the screen simply reverse the above process. Using the pull handle in the center of the pull rod slowly and steadily lower the screen until it is completely concealed within the housing. (Figure **NOTE: Do not let go of the handle while lowering the screen or the screen will retract too quickly possibly resulting in damage.**)
- Close the top cover, ensure the case is locked, rotate the feet back into the travel position and store the screen.



SCREEN MAINTENANCE & PROPER OPERATING CONDITIONS

- The screen surface may be cleaned with warm water and a soft cotton cloth.
- To prevent marring or smudging the screen surface be careful no to touch the screen surface with your fingers or any object (i.e. pointing device)
- Do not display or store your screen in direct sunlight.
- Do not display your screen in front of a door, window, fan or heating or cooling vent as air flow will disrupt your viewing experience, and direct sunlight could cause fading.
- Handle the screen carefully to avoid damage and prolong the life of your screen.

TheaterNow!